

Studio LED X4 PLUS

SKU: 960-4301 / 960-4302

Publication date 25th September 2023



Table of Contents

Copyright	3
Introduction	4
General Delivery Notes	5
Technical Specifications	6
Safety Notes	7
Installation	10
Mechanical Installation	10
Electric Installation	11
Control Menu	13
Control Menu Map	14
DMX Chart	15
Programming Control Menu	18
Maintenance and Cleaning	20
Warranty	21
Disclaimer	22

Copyright

Copyright © 2022

All rights reserved.

Original Instructions: English

All rights reserved throughout the world. No part of this publication may be stored in a retrieval system, transmitted, copied or reproduced in any way, including, but not limited to, photocopy, photograph, magnetic or other record without the prior agreement and permission in writing of Videndum Plc.

Disclaimer

The information contained in this publication is believed to be correct at the time of printing. Videndum Ltd reserves the right to make changes to the information or specifications without obligation to notify any person of such revision or changes. Changes will be incorporated in new versions of the publication. We are making every effort to ensure that our publications are updated on a regular basis to reflect changes to product specifications and features. Should this publication not contain information on the core functionality of your product, please let us know. You may be able to access the latest revision of this publication from our website. Videndum Production Solutions Ltd reserves the right to make changes to product design and functionality without notification.

Trademarks

All product trademarks and registered trademarks are the property of Videndum Plc.

All other trademarks and registered trademarks are the property of their respective companies.

Published by:

Videndum Production Solutions Ltd

Email: publications@videndum.com

Introduction

Congratulations on choosing a Litepanels product! We thank you for your custom.

Please note that this product, as well as all the other Litepanels products, has been designed and manufactured with high quality materials and manufacturing processes to ensure excellent performance and to best meet your expectations and requirements.

Carefully read this instruction manual in its entirety and keep it safe for future reference. It is essential to know the information and comply with the instructions given in this manual to ensure the fitting is installed, used and serviced correctly and safely.

Litepanels disclaims all liability for damage to the fitting or to other property or persons deriving from installation, use and maintenance that have not been carried out in conformity with this instruction manual, which must always accompany the fitting.

Litepanels reserves the right to modify the characteristics stated in this instruction manual at any time and without prior notice.

This piece of equipment is for exclusively professional use and must be operated by qualified personnel.

Remember - pieces of equipment which have reached the end of their life cycle are not worthless rubbish: by recycling old equipment we can recover precious materials.

General Delivery Notes

The basic Studio LED X4 PLUS pack contains the following components:

- Projector
- 4-leaf rotating barndoor
- Instruction booklet

Technical Specifications

LIGHT SOURCE	Array LEDs
MAX POWER	150W
CORRELATED COLOR TEMPERATURE	Fixed 3200K-5600K
BEAM ANGLE	15° - 53°
LENS DIAMETER	175 mm
POWER SUPPLY	90 – 260 Vac, 50/60 Hz, autosensing
POWER FACTOR (cosφ)	0,97
WEATHERPROOF RATING	IP20
OPERATIONAL TEMPERATURE (Ta)	0° – 35°
DIMMING	Electronic 16 bit, fully 0 – 100%
CONTROL	Internal temperature sensor, LCD graphic display with switch off function, silent fan, 3 presetting fan speed.
CONNECTIONS	DMX In and Through 5-Pin XLR; USB port for firmware and software upgrade and diagnostic
FEATURES	Internal temperature sensor, LCD graphic display with switch off function, silent fan, 3 presetting fan speed.
MOUNTING	Manual and Pole Operated stirrup.

Dimensions

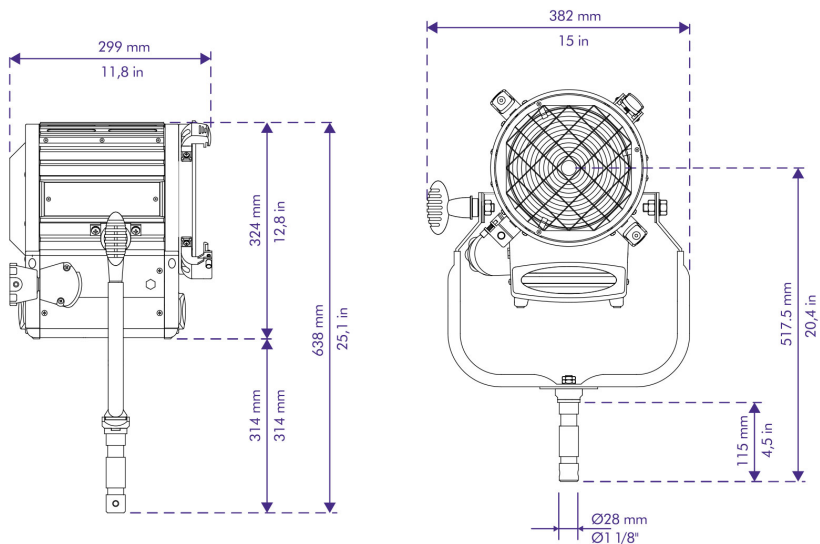

Safety Notes

Important information on the safe installation and operation of this product. Read this information before operating the product. For your personal safety, read these instructions. Do not operate the product if you do not understand how to use it safely. Save these instructions for future reference.

Warning Symbols Used in these Instructions

Important information on the safe installation and operation of this product. Read this information before operating the product. For your personal safety, read these instructions. Do not operate the product if you do not understand how to use it safely. Save these instructions for future reference.



WARNING

Where there is a risk of personal injury or injury to others, comments appear supported by the warning triangle symbol. Where there is a risk of damage to the product, associated equipment, process or surroundings, comments appear supported by the word 'Caution'.



DANGER

Where there is a risk of electric shock, comments appear supported by the hazardous voltage warning triangle.

Electrical Connection



DANGER

Risk of electric shock. Do not remove cover, no user servicable parts inside the product.



WARNING

Risk of electric shock. Always check cables for signs of damage. Damaged cables can cause personal injury and/or damage the equipment.



DANGER

Refer servicing to qualified service personnel.

Operation



WARNING

Special precautions and handling instructions are contained in this user guide and should be strictly adhered to for safe and reliable operation.



WARNING

Never use flammable or combustible materials and solvents around lights.



CAUTION

The product should not be used outside the operating temperature limits. Refer to the product technical specifications for the operating limits for the product.



WARNING

Protect the product from water, moisture and dust. The presence of electricity near water can be dangerous.



CAUTION

Do not directly look into the light, it can cause harm to your eyes.



CAUTION

Do not look at the LEDs with a magnifying glass or any other optical instrument that may concentrate the light output.



NOTE

This device is for exclusively professional use and must be operated by qualified personnel



IMPORTANT

Only substitute fuses with others of the same type and value.



IMPORTANT

This device must be earthed.



IMPORTANT

Class 1 device. The protection conductor must be part of the power cable.



IMPORTANT

Disconnect power before opening the device (authorised personnel).



IMPORTANT

Avoid exposing the device to atmospheric agents such as rain, damp, etc.



IMPORTANT

If the power cable is damaged it must immediately be replaced with a suitable cable exclusively available from the Litepanels assistance service or authorised Litepanels service centres.



DANGER

The illuminator must never be used near to inflammable sources or materials.



DANGER

Do not cover the device's cooling ducts as they are essential for correct ventilation.



IMPORTANT

Use exclusively Litepanels accessories and spare parts.



IMPORTANT

Litepanels does not accept responsibility for damage or malfunctions caused by not observing these instructions or by unauthorised modifications of the device.

Damage caused by modifications or tampering are not covered by the warranty.



IMPORTANT

THE ILLUMINATOR MUST BE EARTHED

Before connecting the illuminator to the power supply, ensure that the voltage and frequency used correspond to the illuminator's nominal values. The Studio LED Plus/BICOLOR works at a voltage 90-260V monophasic current and 50-60 Hz.

Maintenance



DANGER

The fitting of non-approved parts or accessories, or the carrying out of non-approved alterations or servicing can be dangerous and could affect the safety of the product. It may also invalidate the terms and conditions of the product warranty.



DANGER

Never attempt to service this light. Refer servicing to qualified service personnel.

Installation

MECHANICAL INSTALLATION

The Studio LED X4 PLUS can be positioned directly on the stage floor, on a tripod or hanged on a truss or on the ceiling or wall without altering its operation characteristics.

Before suspending the illuminator, ensure that the carrying structure is capable of holding the weight of the device and that it is supplied with suitable secondary safety systems (steel cable, chains, etc.).

The installation must always be secured with a secondary safety attachment, e.g. an appropriate catch net.

This secondary safety attachment must be constructed in a way that no part of the installation can fall down if the main attachment fails.

When rigging, derigging or servicing the fixture, staying in the area below the installation place, on bridges, under high working places and other endangered areas is forbidden.

The operator has to make sure that safety-relating and machine-technical installations are approved by an expert before taking into operation for the first time and after changes before taking into operation another time.

The operator has to make sure that safety-relating and machine-technical installations are approved by an expert after every four year in the course of an acceptance test.

The operator has to make sure that safety-relating and machine-technical installations are approved by a skilled person once a year.



IMPORTANT

OVERHEAD RIGGING REQUIRES EXTENSIVE EXPERIENCE, including (but not limited to): calculating working load limits, installation material being used, and periodic safety inspection of all installation material and the projector. If you lack these qualifications, do not attempt the installation yourself, but instead use a professional structural rigger. Improper installation can result in bodily injury or damage to property.

The fixture has to be installed out of the reach of people.

If the fixture shall be lowered from the ceiling or high hoists, professional trussing systems have to be used.



CAUTION

Fixture may cause severe injuries when crashing down! If you have doubts concerning the safety of a possible installation, do not install the fixture.

Before rigging make sure that the installation area can hold a minimum point load of 10 times the fixture's weight.

When installing the device, make sure there is no highly inflammable material (decoration articles, etc.) in a distance of min. 0.4 m.



CAUTION

Use an appropriate clamp to rig the fixture on the truss. **Make sure that the device is fixed properly!**

For securing a fixture to the truss install a safety wire that can hold at least 10 times the weight of the fixture.

Use only safety wire with screw-on carabine. **Fasten the safety cable in the attachment point and around the truss.**

ELECTRIC INSTALLATION



IMPORTANT

FIXTURE MUST BE INSTALLED BY A QUALIFIED ELECTRICIAN IN ACCORDANCE WITH ALL NATIONAL AND LOCAL ELECTRICAL AND CONSTRUCTION CODES AND REGULATION

The Studio LED X4 PLUS series fixture operates on AC power, 90 – 260 Vac, 50/60 Hz, autosensing. It will automatically adjust its operation to suit any frequency or voltage within this range.

The fixture must be connected to a non-dimmable power source in order to avoid damage to its internal power supply and other electrical components.

Connection to mains power

1. Install a suitable plug on the power cord. Note that the cores in the power cord are coloured according to the following table.

COLOUR	PIN	STANDARD
BLUE	NEUTRAL	N
BROWN	LIVE	L
GREEN/YELLOW	HEART	

2. Set the switch to OFF (0)
3. Connect the A/C cable to the main power.
4. Set the switch to ON (1).

This device falls under class 1 and must be earthed (grounded)! The earth has to be connected! If you have any doubt about proper installation, consult a qualified electrician.

The use of a thermal/magnetic circuit breaker is recommended.



IMPORTANT

FOR PROTECTION FROM ELECTRIC SHOCK THE FIXTURE MUST BE EARTHED

DMX 512 connection

The fixture is equipped with 5-pin XLR sockets for DMX input and output.

Only use a cable conforming to specifications EIA RS-485, 2-pole twisted pair, shielded, 120Ohm characteristic impedance, 22-24 AWG, low capacity with 5-pin XLR-plugs and connectors in order to connect the controller with the fixture or one fixture with another.

Do not use microphone cable or other cable with characteristics differing from those specified.

DMX OUTPUT
XLR 5 PANEL SOCKET
Pin 1 - Shield
Pin 2 - Data (-)
Pin 3 - Data (+)
Pin 4 - Not connected
Pin 5 - Not connected

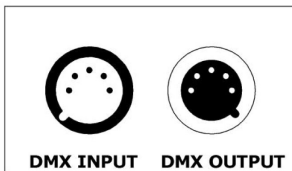

DMX INPUT
XLR 5 PANEL PLUG
Pin 1 - Shield
Pin 2 - Data(-)
Pin 3 - Data (+)
Pin 4 - Not connected
Pin 5 - Not connected

If you are using the standard DMX controllers, you can connect the DMX output of the controller directly with the DMX input of the first fixture in the DMX-chain. If you wish to connect DMX-controllers with other XLR-outputs, you need to use adapter-cables.

Building a serial DMX-chain:

Connect the DMX-output of the first fixture in the DMX-chain with the DMX-input of the next fixture. Always connect one output with the input of the next fixture until all fixtures are connected. Up to 32 fixtures can be interconnected.



CAUTION

The last fixture has to be terminated with a terminator plug. Solder a 120 Ω resistor (minimum ¼ W) between Signal (-) and Signal (+) into a 5-pin XLR-plug and plug it in the DMX-output of the last fixture.



WARNING

The wires must not make contact with each other or with the metal casing of the connectors. The casing itself must be connected to the shield braid and to pin 1 of the connectors.

Control Menu

The Studio LED X4 PLUS is equipped with a backlit LCD which allows to set the fixture's behaviour according to your needs, to display all of the information of the fixture and a Keypad to access and navigate through the menu.

Use the LCD and keypad to program the fixture for your specific application.

To split from DMX mode to Manual mode press **[ESC/MODE]** only when you are in the Home screen.



- **[ESC/MODE]** button used to leave the menu without saving changes. Double presses of the **[ESC/MODE]** button take you back in Home screen. In the Home Screen the button **[ESC/MODE]** activate the Potentiometer for manual dimming.
- **[ENTER]** button is used to enter the selected menu and to confirm adjusted parameter.
- **[UP]** button increases a parameter or menu choice by one. Pressing and holding the push button increases the rate of change.
- **[DOWN]** button decreases a parameter or menu choice by one. Pressing and holding the push button increases the rate of change.
- **[POTENTIOMETER]** is only active in Manual mode, the local potentiometers allows to control light intensity and CCT adjustment manually. The dimming level and the CCT are shown in the display.
- **[USB]** USB port is used to connect the Studio LED X4 PLUS to a PC to upgrade the firmware, make a check up of the fixture, change the system parameters.

After switching the fixture on, display shows current **DMX address** if the Studio LED X4 PLUS is setted in DMX mode or **Manual mode** if the Studio LED X4 PLUS is setted in local dimming, internal temperature of the array led, fan speed, graphic light intensity, percentage light intensity.

Control Menu Map

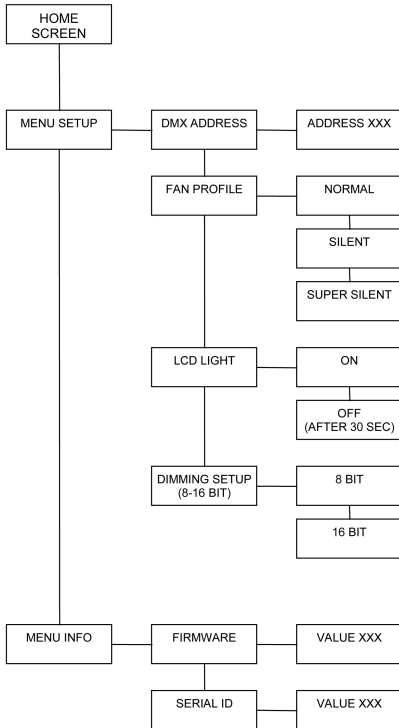

DMX Chart

DMX CH1 %	POWER %	DMX CH2 %	CCT K REALE
0	0	0	2700
1	1	1	2750
2	2	2	2800
3	3	3	2850
4	4	4	2900
5	5	5	2950
6	6	6	3000
7	7	7	3050
8	8	8	3100
9	9	9	3150
10	10	10	3200
11	11	11	3250
12	12	12	3300
13	13	13	3350
14	14	14	3400
15	15	15	3450
16	16	16	3500
17	17	17	3550
18	18	18	3600
19	19	19	3650
20	20	20	3700
21	21	21	3750
22	22	22	3800
23	23	23	3850
24	24	24	3900
25	25	25	3950
26	26	26	4000
27	27	27	4050
28	28	28	4100
29	29	29	4150
30	30	30	4200
31	31	31	4250
32	32	32	4300
33	33	33	4350
34	34	34	4400
35	35	35	4450
36	36	36	4500
37	37	37	4550
38	38	38	4600
39	39	39	4650

40	40	40	4700
41	41	41	4750
42	42	42	4800
43	43	43	4850
44	44	44	4900
45	45	45	4950
46	46	46	5000
47	47	47	5050
48	48	48	5100
49	49	49	5150
50	50	50	5200
51	51	51	5250
52	52	52	5300
53	53	53	5350
54	54	54	5400
55	55	55	5450
56	56	56	5500
57	57	57	5550
58	58	58	5600
59	59	59	5650
60	60	60	5700
61	61	61	5750
62	62	62	5800
63	63	63	5850
64	64	64	5900
65	65	65	5950
66	66	66	6000
67	67	67	6050
68	68	68	6100
69	69	69	6150
70	70	70	6200
71	71	71	6250
72	72	72	6300
73	73	73	6350
74	74	74	6400
75	75	75	6450
76	76	76	6500
77	77	77	6500
78	78	78	6500
79	79	79	6500
80	80	80	6500
81	81	81	6500
82	82	82	6500
83	83	83	6500

84	84	84	6500
85	85	85	6500
86	86	86	6500
87	87	87	6500
88	88	88	6500
89	89	89	6500
90	90	90	6500
91	91	91	6500
92	92	92	6500
93	93	93	6500
94	94	94	6500
95	95	95	6500
96	96	96	6500
97	97	97	6500
98	98	98	6500
99	99	99	6500
100	100	100	6500

Programming Control Menu

DMX ADDRESS

Allows you to set the DMX ADDRESS of the fixture.

1. On the Home screen press **[DOWN]** to scroll to **Menu setup** and then press **[Enter]**.
2. Use the **[Up]** and **[Down]** button to scroll to **DMX Address** and then press **[Enter]**.
3. Use **[Up]** or **[Down]** to scroll to the desired **address**.
4. Press **[Enter]** to confirm the selection or **[ESC]** to keep current settings.
5. Press **[ESC]** twice to return to the home screen.

FAN PROFILE

It lets you select the three available fan profiles of the fixture.

1. On the Home screen press **[DOWN]** to scroll to **Menu setup** and then press **[Enter]**.
2. Use the **[Up]** and **[Down]** button to scroll to **FAN PROFILE** and then press **[Enter]**.
3. Use **[Up]** or **[Down]** to select one of the following setting:
Normal: Maximum speed and consequently maximum effects noise level. Silent: reduces the speed of the fan, thereby reducing the noise level. Super Silent: keeps to a minimum the speed of the fan in order to silence the device.
4. Press **[Enter]** to confirm the selection or **[ESC]** to keep current settings.
5. Press **[ESC]** twice to return to the home screen.

LCD LIGHT

Used for automatically OFF the light on the display after 30 seconds.

1. On the Home screen press **[DOWN]** to scroll to **Menu setup** and then press **[Enter]**.
2. Use the **[Up]** and **[Down]** button to scroll to **LCD LIGHT** and then press **[Enter]**.
3. Use **[Up]** or **[Down]** to select **ON** or **OFF** of the backlight of the LCD.
4. Press **[Enter]** to confirm the selection or **[ESC]** to keep current settings.
5. Press **[ESC]** twice to return to the home screen. The setting appears on the display (on or off)

DIMMING SETUP

Enables the two different values of dimming between 8 or 16 bit

1. On the Home screen press **[DOWN]** to scroll to **Menu setup** and then press **[Enter]**.
2. Use the **[Up]** and **[Down]** button to scroll to **DIMMING SETUP** and then press **[Enter]**.
3. Use **[Up]** or **[Down]** to select one of the following setting:
8 bit: for normal dimming 0-100% (one channel) 16 bit: for fine dimming 0-100% (two channels)
4. Press **[Enter]** to confirm the selection or **[ESC]** to keep current settings.
5. Press **[ESC]** twice to return to the home screen. The setting appears on the display (8 or 16)

FIRMWARE

Used for displaying the software version of CPU board installed in the device.

1. On the Home screen press **[DOWN]** to scroll to **Menu info** and then press **[Enter]**.
2. Use the **[Up]** and **[Down]** button to scroll to **FIRMWARE** and then press **[Enter]**.
3. The LCD displays the version of the firmware installed
4. Press **[ESC]** twice to return to the home screen.

SERIAL ID

Used for displaying the Network parameters of the projector.

1. On the Home screen press **[DOWN]** to scroll to **Menu info** and then press **[Enter]**.
2. Use the **[Up]** and **[Down]** button to scroll to **SERIAL ID** and then press **[Enter]**.
3. The LCD displays the ID number.
4. Press **[ESC]** twice to return to the home screen.

Maintenance and Cleaning



WARNING

DISCONNECT FROM THE MAINS BEFORE STARTING ANY MAINTENANCE WORK

To ensure the maximum performance of your Studio LED X4 Plus BI-COLOR it is absolutely essential that the fixture is kept clean.

Regular cleaning will not only ensure the maximum light-output, but will also allow the fixture to function reliably throughout its life.

You should perform the following inspections and cleaning at least once a year. You may need to inspect or clean the fixture more often, depending on the type and amount of use.

Lenses and reflecting mirror may require monthly cleaning as dust, dirt and smoke-fluid tends to building up residues, reducing the light-output very quickly. Use a clean, soft clothe to clean the lens.



IMPORTANT

NEVER USE ALCOHOL OR SOLVENTS FOR CLEANING LENSES OR REFLECTORS, USE WET CLOTHE ONLY

The cooling fan should be cleaned according to the situation (at least annually).

The interior of the base should be cleaned at least annually using a vacuum-cleaner or an air-jet. More complicated maintenance and service operations are only to be carried out by authorized service centre.

Check the correct working of the mechanical parts and, if needed, replace them. Make sure the projector is not mechanically damaged. If necessary, replace the worn parts.

Check all electrical connections, in particular for correct grounding and correct attachment of all extractable connectors. Press the connectors if necessary and reposition as before.



NOTE



This symbol and recycling system are valid only for member countries of the European Union.

This product was constructed with high-quality materials and components, which can be reused and recycled.

According to Directive 2002/95/EC of the European Parliament and of the Council of 27 January 2003 on the restriction of the use of certain hazardous substances in electrical and electronic equipment, at the end of their useful life, electrical and electronic equipment bearing this symbol must be collected separately and directed to the appropriate authorized WEEE recycling center.

Illegal waste disposal would result in an administrative sanction provided for in the national law.

Warranty

In order for a product to be covered under Litepanels warranty, the customer must provide proof of purchase. However, please note that this warranty is transferable.

2 Year warranty from date of purchase.

Customer must provide proof of purchase.

This warranty is transferable.

Litepanels will pay for:

The replacement parts, repair and/or labor costs to correct defects in materials and workmanship.

Service must be provided by Litepanels or an Authorized Litepanels Service Center

Litepanels will not pay for:

Damage resulting from accident, misuse or abuse. Acts of God. Any failure that occurs for any other reason than materials and workmanship. Any shipping or handling costs.

Disclaimer of implied warranties / limitations of remedies:

Implied warranties, including the extent applicable warranties of merchantability or fitness for a particular purpose are excluded to the extent legally permissible. Any implied warranties that may be imposed by law are limited to 2 years or the shortest period allowed by law. Some states, provinces or countries do not allow limitations or exclusions on how long an implied warranty of merchantability or fitness lasts, the above limitations or exclusions may not apply to you.

If this product fails to work as warranted, customer's sole and exclusive remedy shall be repair or replacement according to the terms of this limited warranty. Litepanels does not assume any responsibility for incidental or consequential damages. This warranty gives you specific legal rights and you may also have other rights which vary from state to state, province to province or country to country.

Disclaimer

The information contained in this manual is believed to be correct at the time of printing. Videndum Production Solutions Inc. reserves the right to make the changes to the information or specifications without obligation to notify any person of such revisions or changes. Changes will be incorporated in new versions of the publication. We are making every effort to ensure that our manuals are updated on a regular basis to reflect changes to the product specifications and features. Should this manual not contain information on the core functionality of your product, please let us know. You may be able to access the latest revision of this manual from our website. Videndum Production Solutions Inc. reserves the right to make changes to product design and functionality without notification.

TRADEMARKS

All product trademarks and registered trademarks are the property of Videndum Plc. All other trademarks and registered trademarks are the property of the respective companies.

PUBLISHED BY:

Videndum Production Solutions Inc. Email: technical.publications@videndum.com

Copyright 2022 - Videndum Production Solutions Inc. All rights reserved

